



swiss bed concept

HASENA
the dream factory



WOOD LINE

Buche massiv | hêtre massif | beech solid

Achten Sie auf FSC®-zertifizierte Produkte | soyez attentifs aux produits certifiés FSC® | look for FSC®-certified products



The mark of
responsible forestry



Bettrahmen | cadre de lit | bedframe

Classic 16 FSC

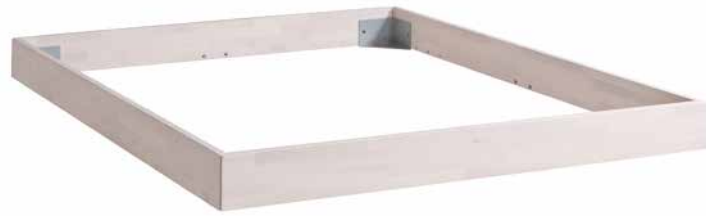

Breiten | largeurs | widths:
90, 100, 120, 140, 160, 180, 200 cm

Längen | longueurs | lengths:
190, 200, 210, 220 cm

Einlegetiefe | hauteur encastrable | insertion depth:
16 cm

Premium 18 FSC



Breiten | largeurs | widths:
90, 100, 120, 140, 160, 180, 200 cm

Längen | longueurs | lengths:
190, 200, 210, 220 cm

Einlegetiefe | hauteur encastrable | insertion depth:
18 cm

Premium 23 FSC



Breiten | largeurs | widths:
120, 140, 160, 180, 200 cm

Längen | longueurs | lengths:
200, 210, 220 cm

Einlegetiefe | hauteur encastrable | insertion depth:
18*, 23 cm

Ausführungen | exécutions | executions

Holz | bois | wood

Buche massiv, stabverleimt

Hêtre massif, panneaux lamellés-collés
Solid beech, laminated blockboard



06
Buche natur, lackiert
Hêtre naturel, laqué
Natural beech, lacquered



07
Buche schoko, lackiert
Hêtre teinté chocolat, laqué
Beech chocolate coloured, lacquered



08
Buche kirschbaumfarbig, lackiert
Hêtre teinté merisier, laqué
Beech cherry coloured, lacquered



09
Buche weiss lasiert, lackiert
Hêtre teinté blanc lasuré, laqué
Beech white stained, lacquered



80
Kernbuche natur, geölt
Hêtre cœur rouge naturel, huilé
Heart beech natural, oiled



81
Buche walnuss geölt
Hêtre teinté noyer huilé
Beech walnut oiled

Traversen | traverses | bars

Wir empfehlen grundsätzlich den Einsatz von Crosstraver (Quertraverse) oder Midtraver (Längstraverse).

Nous recommandons en général l'utilisation de Crosstraver (traverse transversale) ou Midtraver (traverse centrale).
We recommend basically the insertion of Crosstraver (central cross bar) or Midtraver (central bar).

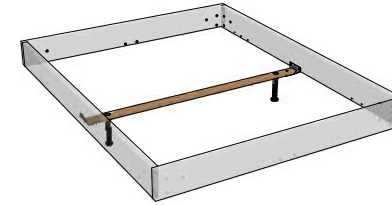

Crosstraver
Quertraverse | traverse transversale | central cross bar

Für alle Bettbreiten | pour toutes les largeurs de lit | for all bed widths

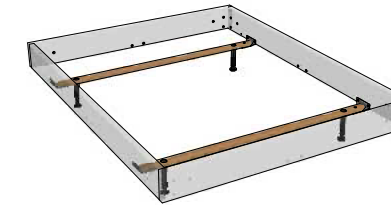

Crosstraver-Twin
Quertraversen | traverses transversales | cross bars

Für alle Bettbreiten | pour toutes les largeurs de lit | for all bed widths

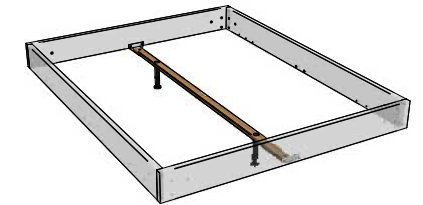

Midtraver
Längstraverse | traverse centrale | central bar

Für Betten ab Breite 160 cm mit 2 Lattenrosten oder Motorrahmeneinbau | pour les lits à partir de 160 cm de largeur avec 2 sommiers ou l'installation d'un cadre motorisé | for beds from 160 cm width with 2 slats or motor frame installation

Achtung: Crosstraver ist nicht mit den Füßen Lovie-Box und Practico-Box einsetzbar

Attention : Crosstraver ne peut pas être utilisée avec les pieds Lovie-Box et Practico-Box
Attention: Crosstraver cannot be used with the Lovie-Box and Practico-Box

Achtung: Crosstraver-Twin ist nicht mit den Füßen Evio, Vilo, Lovie-Box und Practico-Box einsetzbar

Attention : Crosstraver-Twin ne peut pas être utilisée avec les pieds Evio, Vilo, Lovie-Box et Practico-Box
Attention: Crosstraver-Twin cannot be used with legs Evio, Vilo, Lovie-Box and Practico-Box

Achtung: Midtraver ist nicht mit den Füßen Evio, Vilo, Lovie-Box und Practico-Box einsetzbar

Attention : Midtraver ne peut pas être utilisée avec les pieds Evio, Vilo, Lovie-Box et Practico-Box
Attention: Midtraver cannot be used with legs Evio, Vilo, Lovie-Box and Practico-Box

* Premium 23

Bei der Einlegetiefe 18 cm sind die Füße/Sockel um 5 cm versenkt und um diese Höhe weniger sichtbar.

Avec les équerres en position haute (18 cm) les pieds/socle sont encastrés de 5 cm sous le cadre et donc moins visibles.

With the insertion depth 18 cm the feet/socket are sunken in by 5 cm and this height less visible.

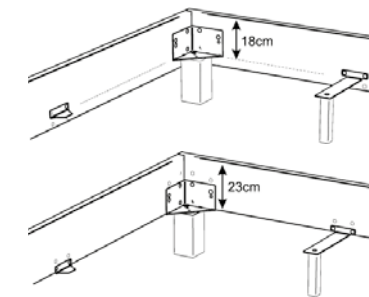

Option Midtraver-move

Achtung: nicht bei Füßen in der Höhe 30 cm, Lovie-Box und Practico-Box einsetzbar

Attention : ne s'applique pas aux pieds à une hauteur de 30 cm, Lovie-Box et Practico-Box

Attention: not applicable for feet at a height of 30 cm, Lovie-Box and Practico-Box

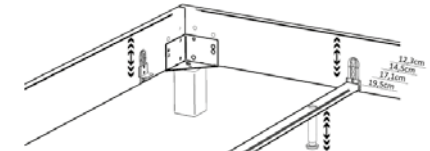

Modern, einzigartig, wertbeständig

Unsere Wood-Line ist ebenso langlebig wie das Holz, aus dem es gemacht ist und bietet Schlafkomfort auf hohem Niveau: modern, zeitlos und wertbeständig. Natürlich gewachsene Unregelmäßigkeiten in Farbe, Maserung und Oberfläche schenken dem massiven Holz und den Möbeln dieser Linie einen sehr natürlichen und einzigartigen Charakter.

Buche stabverleimt massiv

Buchenholz ist hell-gelblich bis rosabraun mit schwacher Textur. Der farblich gleichmäßige Aufbau mit zungenförmiger Maserung verleiht ihm sein charakteristisches Aussehen.

Kernbuche stabverleimt massiv

Bei der Kernbuche handelt es sich nicht um eine eigene Buchenart, sondern um eine ältere Rotbuche. Bei diesen Buchen entsteht, als natürliche Begleiterscheinung, eine Rotfärbung des Holzes im Stammesinneren. Meist tritt diese Kernbildung erst ab einem Alter von 100 bis 120 Jahren auf. Das Holz der Kernbuche wirkt somit auffälliger und rustikaler als das der Buche.

Moderne, unique, stable in valeur

Le concept Wood-Line est aussi durable que le bois dont il est fait et offre un grand confort de sommeil : moderne, intemporel et durable. Les irrégularités naturelles de couleur, de grain et de surface donnent au bois massif et aux meubles de cette ligne un caractère très naturel et unique.

Hêtre lamellé-collé massif

Le bois de hêtre est jaunâtre clair à brun rosé avec une texture faible. La structure uniformément colorée avec un grain en forme de langue lui donne son aspect caractéristique.

Hêtre cœur rouge lamellé-collé massif

Le bois de cœur de hêtre n'est pas une essence de hêtre en soi, mais un hêtre plus ancien. Ces hêtres sont naturellement accompagnés d'une coloration rouge du bois à l'intérieur du tronc. Habituellement, cette nucléation ne se produit qu'à partir de l'âge de 100 à 120 ans. Le bois du cœur de hêtre apparaît ainsi plus visible et rustique que celui du hêtre.

Modern, unique, stable in value

The Wood-Line concept is just as durable as the wood it is made of and offers a high level of sleeping comfort: modern, timeless and of lasting value. Naturally grown irregularities in colour, grain and surface give the solid wood and furniture of this line a very natural and unique character.

Solid stick-glued beech

Beech wood is light yellowish to pinkish brown with a weak texture. The evenly coloured structure with tongue-shaped grain gives it its characteristic appearance.

Solid stick-glued heart beech

The beech heartwood is not a beech species of its own, but an older beech. These beech trees are naturally accompanied by a red colouring of the wood inside the trunk. Usually this nucleation occurs only from an age of 100 to 120 years. The wood of the beech heartwood thus appears more conspicuous and rustic than that of the beech.

Füsse | pieds | feet

Holz | bois | wood



Standard: gedämpfter Selbststeinzug Blumotion von BLUM
Option: Tip-on-Öffnung mit Vollauszug von BLUM
standard: système d'amortissement Blumotion de BLUM
option: ouverture Tip-on avec sortie totale de BLUM
standard: soft closing runner Blumotion of BLUM
option: opening Tip-on with full extension of BLUM

Holz bois wood	Masse cm dim. cm	Breiten cm largeurs cm widths cm	Höhen cm hauteurs cm heights cm				Holzfarben couleurs bois colours wood										
			10	20	25	30	06	07	08	09	10	16	80	81			
Amigo*	10x10																
Cantu	8x8																
Evio		90-200															
Ivio	10x10																
Juve	8x8																
Leno	6x5,5																
Lovie-Box** (1 Schublade/tiroir/drawer)		90-140															
Lovie-Box** (2 Schubladen/tiroirs/drawers)		140-200															
Massa**	16x16																
Practico-Box (inkl. Boden fond inclus bottom included)		90-200															
Vilo		90-200															

* nur mit Classic 16 Rahmen möglich | uniquement possible avec cadre Classic 16 | only possible with frame Classic 16
 ** bei Premium 23 nur Einlegetiefe 23 cm möglich | pour Premium 23 uniquement possible avec hauteur encastrable de 23 cm | for Premium 23 only possible with insertion depth of 23 cm

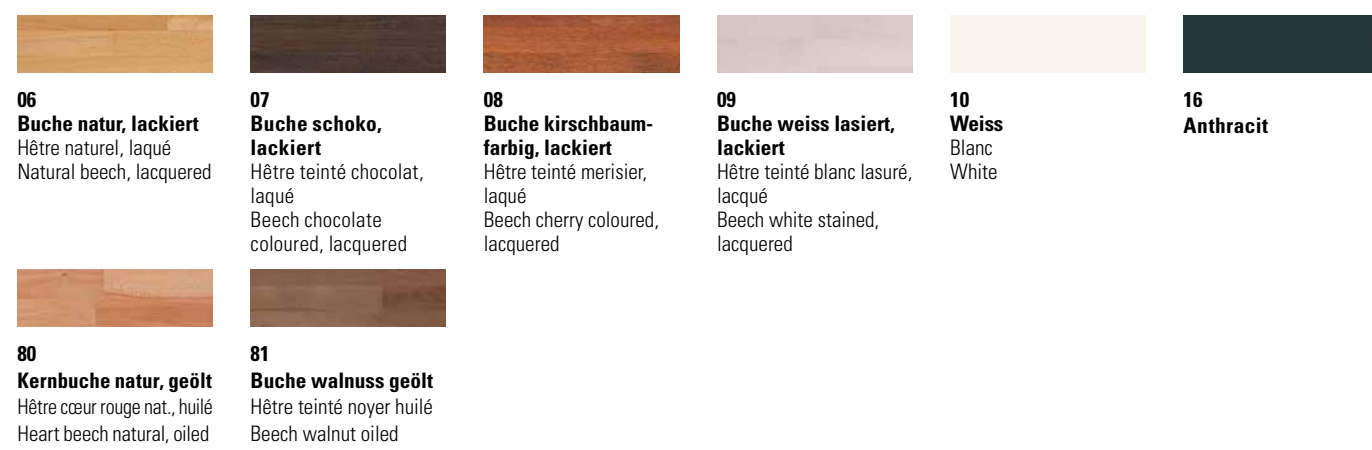

Füsse | pieds | feet

Metall | métal | metal



Metall métal metal	Masse cm dim. cm	Breiten cm largeurs cm widths cm	Höhen cm hauteurs cm heights cm				Metallfarben couleurs métal colours metal											
			10	20	25	30	00	04	10	16	40	41	42	43	45			
Caro	6x6																	
Cielo [▲]		120-200																
Fasio	∅ 5/9																	
Gina*	3,5x3,5																	
Grado	∅ 6/10																	
Indus	6x2	140-200																
Jeno	12x5																	
Jump*	∅ 10/12																	
Mico	8x8																	
Quada	20x6,5																	
Rally	∅ 10																	
Reca	24x12																	
Road**	∅ 13																	
Slid	8/1	140-200																
Soko	∅ 6																	
Stomp	∅ 8																	
Tondo*	∅ 3,5																	

* bei Premium 23 nur Einlegetiefe 23 cm möglich | pour Premium 23 uniquement avec profondeur d'insertion 23 cm | with Premium 23 only 23 cm insertion depth possible
 ** Füße fixiert, Rollen nur optisch | pieds fixes, roulettes uniquement décoration | feet fixed, castors only visual
 ▲ Curty Vorhang und Vela Baldachin-Tuch siehe Register 2, Seite 12 | Curty rideau et Vela tissu de baldachin voir registre 2, page 12 | Curty curtain and Vela canopy cloth see index 2, page 12



Chrom = Metall verchromt | métal chromé | metal chrome
Used = Metall galvanisiert | métal galvanisé | metal galvanised
White = Metall pulverbeschichtet | métal thermolaqué | metal powder-coated
Anthracit = Metall pulverbeschichtet | métal thermolaqué | metal powder-coated
Bronze = Metall lackiert | métal laqué | metal lacquered
Copper = Metall lackiert | métal laqué | metal lacquered
Alu = Metall pulverbeschichtet | métal thermolaqué | metal powder-coated
Inox = Edelstahl gebürstet | acier inoxydable brossé | stainless steel brushed
Iron = Metall geflammt, pulverbeschichtet | métal flammé, thermolaqué | metal mottled, powder-coated

Bettkasten mit Holzkufe | tiroir de lit avec patins en bois | bed drawer with wooden vat

Lovie-Box + Covero 
90-140 cm 1 Schublade | 1 tiroir | 1 drawer

Stauraum | compartiment de rangement | storage space:
134 × 61 × 16 cm

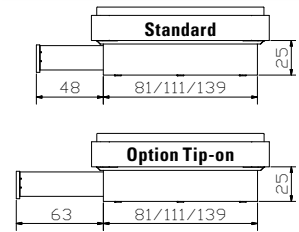

Standard: gedämpfter Selbststeinzug Blumotion von BLUM
Option: Tip-on-Öffnung mit Vollauszug von BLUM

Lovie-Box + Saceto 
140-200 cm 2 Schubladen | 2 tiroirs | 2 drawers

Stauraum | compartiment de rangement | storage space:
2 × 134 × 61 × 16 cm

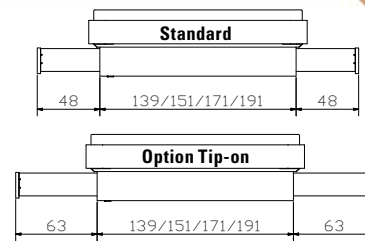

standard: système d'amortissement Blumotion de BLUM
option: ouverture Tip-on avec sortie totale de BLUM
standard: soft closing runner Blumotion of BLUM
option: opening Tip-on with full extension of BLUM

Roll-Box 20/25 



Voraussetzungen für Einsatz Bettkasten
Generell
Bettfußhöhe von mindestens 20 oder 25 cm erforderlich.
Seitlich
mit Midtraver möglich.
Optionen
Deckel Covero in weiss, Stoffabdeckung Saceto in Polyester grau.

Roll-Box 20/25 + Covero 



Conditions d'utilisation d'un tiroir de lit
En général
Une hauteur de pieds de lit d'au moins 20 cm ou 25 cm est nécessaire.
Insertion latérale
avec Midtraver possible.
Options
Couvercle Covero en blanc, tissu de protection Saceto en polyester gris.

Roll-Box 20/25 + Saceto 



Requirements for using bed drawer
General
Feet of bed need a minimum height of 20 cm or 25 cm.
Laterally
with Midtraver possible.
Options
Covero in white, tissue of protection Saceto in polyester grey.



Roll-Box 20

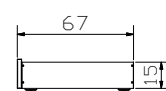

Roll-Box 25

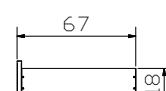

Stauraum | compartiment de rangement | storage space

Roll-Box 20	=	134 × 61 × 13 cm
Roll-Box 25	=	134 × 61 × 16 cm

Bettkasten | coffre à literie | bedding box

Practico-Box + Classic 16 + Ultrafree-Lift KF



Ultrafree-Lift KF



Box = inkl. Boden, Anwendung siehe Seiten 6.34/35
zu Practico-Box:
Lattenrost **Ultrafree-Lift KF**
Kopf-/Fussverstellung
Rahmenholme Höhe 7 cm und 28 Federleisten aus Buchenschichtholz
Gesamthöhe 11 cm

Lattenrost **Econom-move**
Unverstellbar
Rahmenholme Höhe 6 cm und 28 Federleisten aus Buchenschichtholz
Gesamthöhe 9 cm

inkl. Gasdruckfedern und allen Beschlägen

Details zu Ultrafree-Lift KF und Econom-move
siehe Register 13, Seite 6

Practico-Box + Premium 23 + Econom-move



Econom-move



box = fond inclus, utilisation voir pages 6.34/35
pour box Practico:
Sommier **Ultrafree-Lift KF**
Tête et pied réglables
Cadre, hauteur 7 cm et 28 lattes en hêtre multiplis
Hauteur totale 11 cm

Sommier **Econom-move**
Non réglable
Cadre, hauteur 6 cm et 28 lattes en hêtre multiplis
Hauteur totale 9 cm

Pistons à gaz et toute la quincaillerie inclus

Détails pour Ultrafree-Lift KF et Econom-move
voir registre 13, page 6

Stauraum | compartiment de rangement | storage space

90 × 200/210/220	=	81 × 190/200/210 × 24 cm
100 × 200/210/220	=	91 × 190/200/210 × 24 cm
120 × 200/210/220	=	111 × 190/200/210 × 24 cm
140 × 200/210/220	=	131 × 190/200/210 × 24 cm
160 × 200/210/220	=	74 × 190/200/210 × 24 (2 x) cm
180 × 200/210/220	=	84 × 190/200/210 × 24 (2 x) cm
200 × 200/210/220	=	94 × 190/200/210 × 24 (2 x) cm

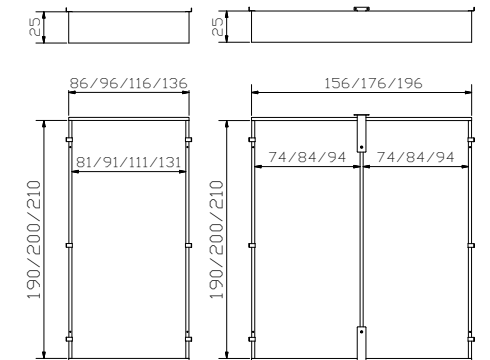

box = bottom incl., handling see pages 6.34/35
for Practico-box:
Slats **Ultrafree-Lift KF**
Head/footpiece adjustable
Frame, height 7 cm and 28 slats are of beech veneer board
Total height 11 cm

Slats **Econom-move**
Not adjustable
Frame, height 6 cm and 28 slats are of beech veneer board
Total height 9 cm

Pneumatic compression spring and all fittings included

Details for Ultrafree-Lift KF and Econom-move
see index 13, page 6

Himmelbett ohne Grenzen lit à baldaquin sans frontières | canopy bed without borders

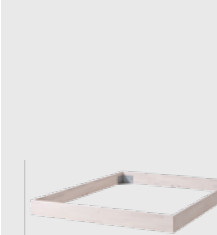

Bettahmen | cadre de lit | bedframe

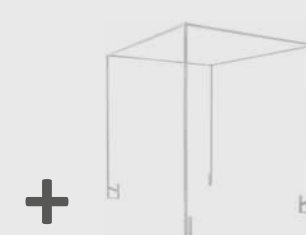

Cielo-Ron | Baldachin | baldaquin | canopy



Kopfteil | tête de lit | headboard



Kopfteile | têtes de lit | headboards



Dimension: 90/100, 120, 140, 160, 180, 200

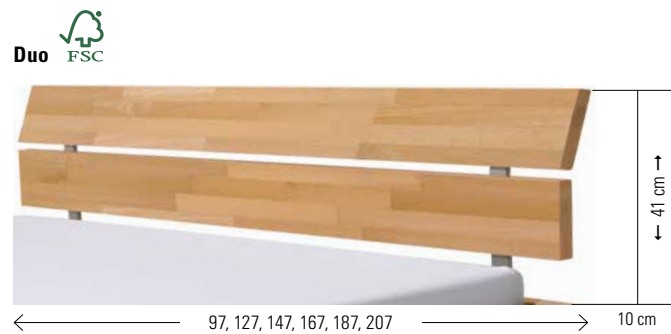

Dimension: 90/100, 120, 140, 160, 180, 200



Dimension: 140, 160, 180/200



Dimension: 90/100, 120, 140, 160, 180/200



Dimension: 140, 160, 180, 200

Ausführungen | exécutions | executions

Holz | bois | wood

06 Buche natur, lackiert Hêtre naturel, laqué Natural beech, lacquered	07 Buche schoko, lackiert Hêtre teinté chocolat, laqué Beech chocolate coloured, lacquered	08 Buche kirschbaumfarbig, lackiert Hêtre teinté merisier, laqué Beech cherry coloured, lacquered	09 Buche weiss lasiert, lackiert Hêtre teinté blanc lasuré, laqué Beech white stained, lacquered	80 Kernbuche natur, geölt Hêtre cœur rouge naturel, huilé Heart beech natural, oiled	81 Buche walnuss geölt Hêtre teinté noyer huilé Beech walnut oiled

Kissen zu Kopfteilen | coussins pour têtes de lit | cushions for headboards

Arona + Duetto



Ravo + Varus



Varo + Varus



Lumo + Duetto



Suny + Litto



Befestigung mit 2 Bändern (Klettverschluss)

Fixation avec 2 bandes (Velcro®)
Fixation with 2 ribbons (Velcro®fastener)

Stoffauswahl/Farben für Kissen siehe Register 1, Seiten 6–7

Choix de tissus/couleurs pour coussins voir registre 1, pages 6–7
Choice of tissues/colours for cushions see index 1, pages 6–7

Kissen coussins cushions	Effektive Masse cm dimensions effectives cm effective dimensions cm	zu Kopfteilen pour têtes de lit for headboards			Breitenmasse cm dimensions de largeur cm widths dimensions cm
		Duetto	Litto	Varus	
Arona	86, 116, 136, 156, 176×3,5×25	●			90/100, 120, 140, 160, 180/200
Lumo	86, 116, 136, 156, 176×6×25	●			90/100, 120, 140, 160, 180/200
Suny (2er Set set de 2 set of 2)	55×6×40	●	●	●	
Ravo	80, 110, 130, 150, 170, 190×3,5×35	●	●	●	90/100, 120, 140, 160, 180, 200
Varo (2er Set set de 2 set of 2)	55×10×35	●	●	●	

Adapter | adaptateur | adapter

Bei hohen Matratzen kann mit dem Verlängerungsadapter das Kopfteil um 9 oder 13 cm erhöht werden.

La tête de lit peut être rehaussée de 9 ou 13 cm avec l'adaptateur quand le matelas est plus épais.

With the extension adapter the headboard can be extended 9 or 13 cm if mattresses are high.

Head-Plus Metall | métal | metal

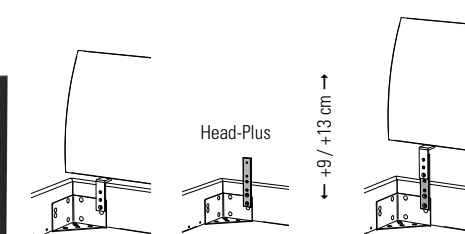

Gepolsterte Kopfteile, Wandpaneele, Stoffauswahl/Farben siehe Register 1, Lampen siehe Register 2.

Têtes de lits rembourrées, panneaux muraux, choix de tissus/couleurs voir registre 1, lampes voir registre 2.
Upholstered headboards, wallpanels, choice of tissues/colours see index 1, lamps see index 2.

Nachttische, Kommoden | tables de nuit, commodes | bedside tables, chests of drawers



	Holzfarben couleurs bois colours wood						Metallfarben couleurs métal colours metal		
	06	07	08	09	80	81	16	42	43
Caja	●	●	●	●	●	●			
Covaro		●		●	●	●			
Dupla	●	●	●	●	●	●			
Esto	●	●	●	●	●	●			
Lovara	●	●	●	●	●	●			
Mido	●	●	●	●	●	●			
Seda	●	●	●	●	●	●			
Silvio							●	●	●
Treva	●	●	●	●	●	●			
Voro		●		●	●	●			

Ausführungen | exécutions | executions

Holz | bois | wood



Beimöbel | accessoires | accessories

Bank + Kissen | banquette + coussin | bench + cushion

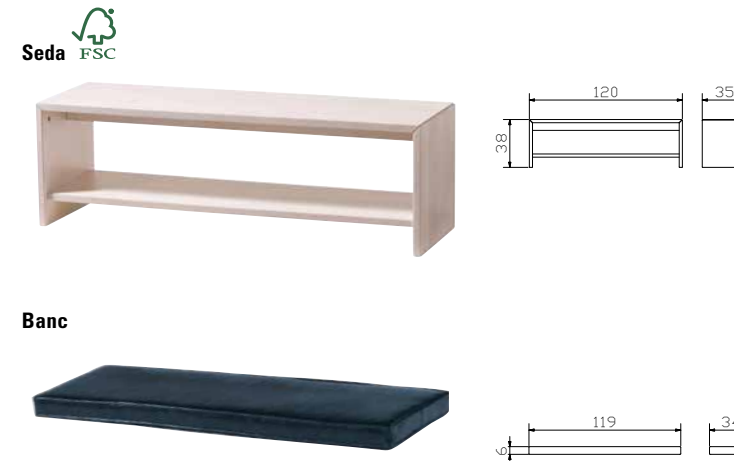

Antirutsch Unterlage (Netz) inklusive
Bande antiglisse incluse
Antiglide net include

Bezugsstoffe siehe Register 1, Seiten 6 – 7
Tissus de revêtement voir registre 1, pages 6 – 7
Cover fabrics see index 1, pages 6 – 7

Herrendiener | valet | dressboy



Füsse | pieds | feet



Fuss Set (4 Stk.) | set de pieds (4 pcs) | set of feet (4 pcs)

Griffe | poignées | handles



*** Covaro und Voro standardmässig mit Holzgriffen, optional Covo, Seca und Rivo Griffe.**
Covaro et Voro standard avec poignées en bois, en option poignées Covo, Seca et Rivo.
Covaro and Voro with wooden handles standard, optional Covo, Seca and Rivo handles

Ausführungen | exécutions | executions

Metall | métal | metal

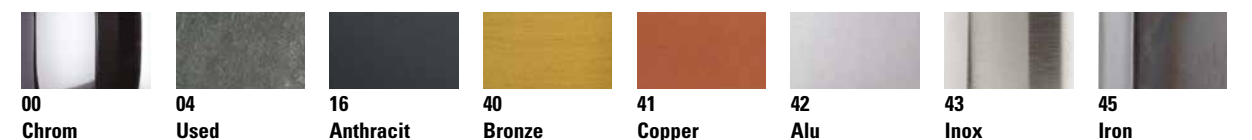

Chrom = Metall verchromt | métal chromé | metal chrome-plated
Used = Metall galvanisiert | métal galvanisé | metal galvanised
Anthracit = Metall pulverbeschichtet | métal thermolaqué | metal powder-coated
Bronze = Metall lackiert | métal laqué | metal lacquered

Copper = Metall lackiert | métal laqué | metal lacquered
Alu = Metall pulverbeschichtet | métal thermolaqué | metal powder-coated
Inox = Edelstahl gebürstet | acier inoxydable brossé | stainless steel brushed
Iron = Metall geflammt, pulverbeschichtet | métal flammé, thermolaqué | metal mottled, powder-coated



				Dimension cm
Lovara	Kommode	commode	chest of drawers	90/40/75
Dupla	Nachttisch	table de nuit	bedside table	48/40/35

				Dimension cm
Classic 16	Rahmen Breiten Längen	cadre largeurs longueurs	frame widths lengths	90, 100, 120, 140, 160, 180, 200 190, 200, 210, 220
Leno	Füße Höhe	pieds hauteur	feet height	20, 25
Boga	Kopfteil, Campos blanc 372 siehe Register 1	tête de lit, Campos blanc 372 voir registre 1	headboard, Campos blanc 372 see index 1	90, 100, 120, 140, 160, 180, 200

Alle Holzteile in Kernbuche natur, geölt | toutes les parties en bois en hêtre coeur rouge naturel, huilé | all wooden parts in heart beech natural, oiled
 Weitere Beimöbel siehe Register 2 | autres accessoires voir registre 2 | further accessories see index 2

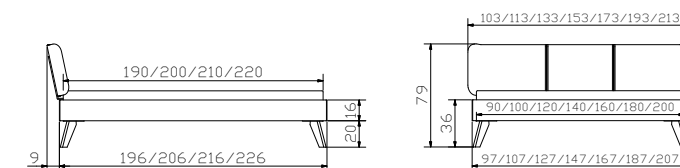



	Dimension cm			
Lovie-Box	1 Bettkasten Breiten	1 tiroir de lit largeurs	1 bed drawer widths	90, 100, 120, 140
	2 Bettkästen Breiten	2 tiroirs de lit largeurs	2 bed drawers widths	140, 160, 180, 200
	Höhe	hauteur	height	25

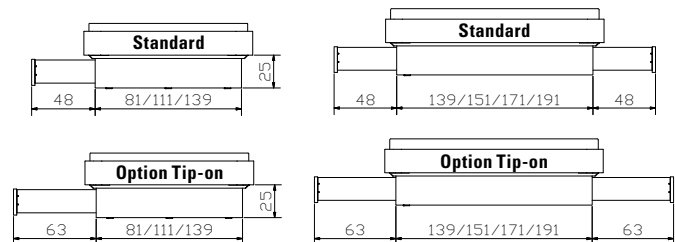

	Dimension cm			
Classic 16	Rahmen Breiten Längen	cadre largeurs longueurs	frame widths lengths	90, 100, 120, 140, 160, 180, 200 190, 200, 210, 220
Indus iron	Kufen Breiten Höhen	patins largeurs hauteurs	vats widths heights	140, 160, 180, 200 20, 25
Elipsa	Kopfteil, Casual cannelle 331 siehe Register 1	tête de lit, Casual cannelle 331 voir registre 1	headboard, Casual cannelle 331 see index 1	90, 100, 120, 140, 160, 180, 200
Caja	Nachttisch	table de nuit	bedside table	48/41/16
Aska	Sekretär	secrétaire	bureau	120/60/85
Circo 44	Nachttisch/Hocker	table de nuit/tabouret	bedside table/stool	Ø 45/44

Alle Holzteile in Kernbuche natur, geölt | toutes les parties en bois en hêtre coeur rouge naturel, huilé | all wooden parts in heart beech natural, oiled

Weitere Beimöbel siehe Register 2 | autres accessoires voir registre 2 | further accessories see index 2

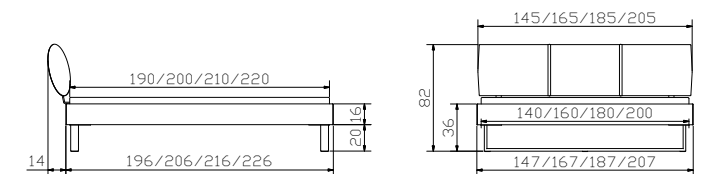



				Dimension cm
Varus	Kopfteil	tête de lit	headboard	140, 160, 180, 200
Duetto	Kopfteil	tête de lit	headboard	90/100, 120, 140, 160, 180, 200
Arona	Kissen, Kitana grigio 602	coussin, Kitana grigio 602	cushion, Kitana grigio 602	90/100, 120, 140, 160, 180/200

				Dimension cm
Classic 16	Rahmen Breiten Längen	cadre largeurs longueurs	frame widths lengths	90, 100, 120, 140, 160, 180, 200 190, 200, 210, 220
Juve	Füße Höhen	pieds hauteurs	feet heights	20, 25
Rino	Kopfteil	tête de lit	headboard	90/100, 120, 140, 160, 180/200
Mido	Nachttisch	table de nuit	bedside table	40/35

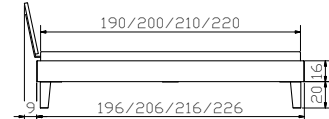
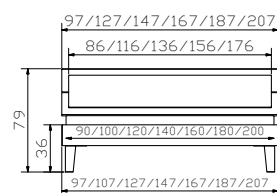
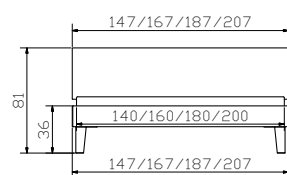

Alle Holzteile in Kernbuche natur, geölt | toutes les parties en bois en hêtre coeur rouge naturel, huilé | all wooden parts in heart beech natural, oiled
Weitere Beimöbel siehe Register 2 | autres accessoires voir registre 2 | further accessories see index 2

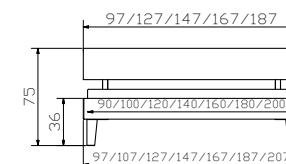
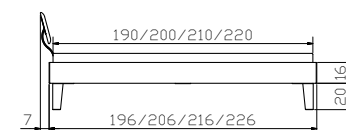



				Dimension cm
Ronna	Kopfteil, Shine rose 681	tête de lit, Shine rose 681	headboard, Shine rose 681	90/100, 120, 140, 160, 180, 200
Duetto	Kopfteil	tête de lit	headboard	90/100, 120, 140, 160, 180, 200
Arona	Kissen, Shine rose 681	coussin, Shine rose 681	cushion, Shine rose 681	90/100, 120, 140, 160, 180/200
Caja	Nachttisch	table de nuit	bedside table	48/41/16

				Dimension cm
Classic 16	Rahmen Breiten Längen	cadre largeurs longueurs	frame widths lengths	90, 100, 120, 140, 160, 180, 200 190, 200, 210, 220
Cantu	Füsse Höhen	pieds hauteurs	feet heights	20, 25, 30
Duetto	Kopfteil	tête de lit	headboard	90/100, 120, 140, 160, 180, 200
Lumo	Kissen, Shine rose 681	coussin, Shine rose 681	cushion, Shine rose 681	90/100, 120, 140, 160, 180/200
Seda	Bank	banquette	bench	120/35/38
Esto	Nachttisch/Hocker	table de nuit/tabouret	bedside table/stool	45/35/38
Roll-Box 20 +Covero	Bettkasten Deckel Covero in weiss	tiroir de lit Couvercle Covero en blanc	bed drawer Covero Covero in white	137/67/19

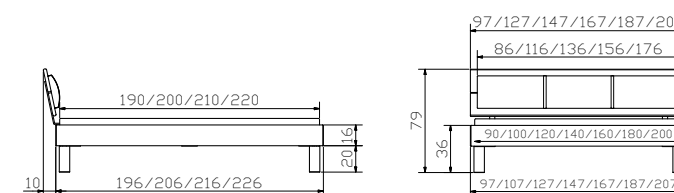
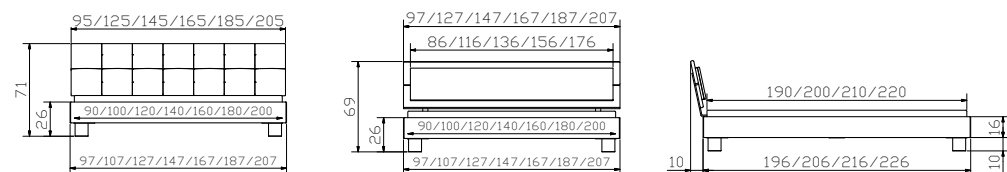

Alle Holzteile in Buche weiss lasiert, lackiert | toutes les parties en bois en hêtre teinté blanc lasuré, laqué | all wooden parts in beech white stained, lacquered

Weitere Beimöbel siehe Register 2 | autres accessoires voir registre 2 | further accessories see index 2



				Dimension cm
Lovara	Kommode	commode	chest of drawers	90/40/75
Treva	Nachttisch	table de nuit	bedside table	48/40/51
Seda	Bank	banquette	bench	120/35/38
Banc	Kissen, Kunstleder white 301	coussin, cuir synthétique white 301	cushion, synthetic leather white 301	119/34/6

				Dimension cm
Classic 16	Rahmen Breiten Längen	cadre largeurs longueurs	frame widths lengths	90, 100, 120, 140, 160, 180, 200 190, 200, 210, 220
Massa	Füße Höhen	pieds hauteurs	feet heights	20, 25, 30
Litto	Kopfteil	tête de lit	headboard	140, 160, 180/200

Alle Holzteile in Buche weiss lasiert, lackiert | toutes les parties en bois en hêtre teinté blanc lasuré, laqué | all wooden parts in beech white stained, lacquered
Weitere Beimöbel siehe Register 2 | autres accessoires voir registre 2 | further accessories see index 2

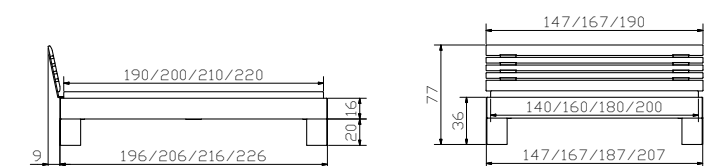



				Dimension cm
Esto	Nachttisch	table de nuit	bedside table	45/35/38

				Dimension cm
Classic 16	Rahmen Breiten Längen	cadre largeurs longueurs	frame widths lengths	90, 100, 120, 140, 160, 180, 200 190, 200, 210, 220
Cantu	Füße Höhen	pieds hauteurs	feet heights	20, 25, 30
Duetto	Kopfteil	tête de lit	headboard	90/100, 120, 140, 160, 180, 200

Alle Holzteile in Buche natur, lackiert | toutes les parties en bois en hêtre naturel, laqué | all wooden parts in natural beech, lacquered
Weitere Beimöbel siehe Register 2 | autres accessoires voir registre 2 | further accessories see index 2

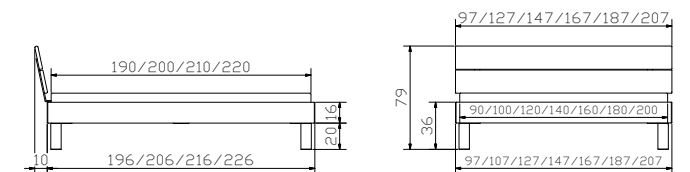



				Dimension cm
Topa bronze	Bank inkl. Kissen Shine musk 683	banquette, coussin incl. Shine musk 683	bench, cushion incl. Shine musk 683	144/44/38
Voro	Nachttisch	table de nuit	bedside table	60/49/38
Rivo bronze	Griffe (2er Set)	poignées (set de 2)	handles (set of 2)	
Smart black	Lampen (2er Set) 12V DC, 30 LED warm	Lampes (set de 2) 12V DC, 30 LED warm	Lamps (set of 2) 12V DC, 30 LED warm	



				Dimension cm
Classic 16	Rahmen Breiten Längen	cadre largeurs longueurs	frame widths lengths	90, 100, 120, 140, 160, 180, 200 190, 200, 210, 220
Tondo bronze	Füße Höhe	pieds hauteur	feet height	20
Lecco	Kopfteil, Shine musk 683 siehe Register 1	tête de lit, Shine musk 683 voir registre 1	headboard, Shine musk 683 see index 1	90/100, 120, 140, 160, 180/200

Alle Holzteile in Buche schoko, lackiert | toutes les parties en bois en hêtre teinté chocolat, laqué | all wooden parts in beech chocolate, lacquered
Lampen und weitere Beimöbel siehe Register 2 | lampes et autres accessoires voir registre 2 | lamps and further accessories see index 2

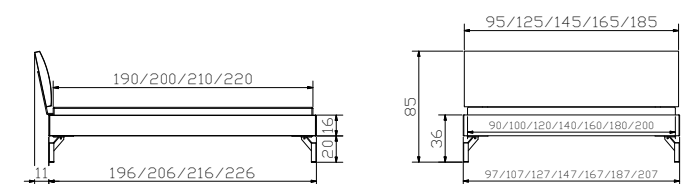



				Dimension cm
Colina L	Wandpaneel, Alpina lightgrey 390 siehe Register 1 Seite 5	panneau mural, Alpina lightgrey 390 voir registre 1 page 5	wall panel, Alpina lightgrey 390 see index 1 page 5	161, 181, 201, 221
Boa chrom	Lampen (2er Set) 12V DC, 12 LED kalt weiss	lampes (set de 2) 12V DC, 12 LED blanc froid	lamps (set of 2) 12V DC, 12 LED cold white	
Lovara	Kommode	commode	chest of drawers	90/40/75

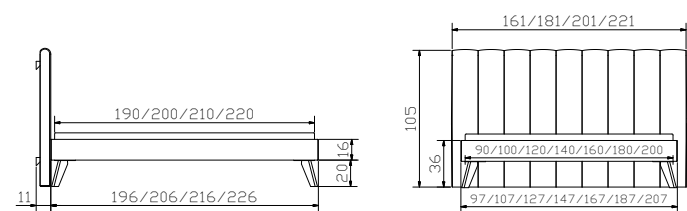

				Dimension cm
Classic 16	Rahmen Breiten Längen	cadre largeurs longueurs	frame widths lengths	90, 100, 120, 140, 160, 180, 200 190, 200, 210, 220
Leno	Füsse Höhe	pieds hauteur	feet height	20, 25
Malta	Kopfteil, Casual olive 333 siehe Register 1	tête de lit, Casual olive 333 voir registre 1	headboard, Casual olive 333 see index 1	120, 140, 160, 180, 200
Caja	Nachttisch	table de nuit	bedside table	48/41/16
Tina chrom	Lampen (2er Set) 12 V DC, 1 LED	lampes (set de 2) 12 V DC, 1 LED	lamps (set of 2) 12 V DC, 1 LED	

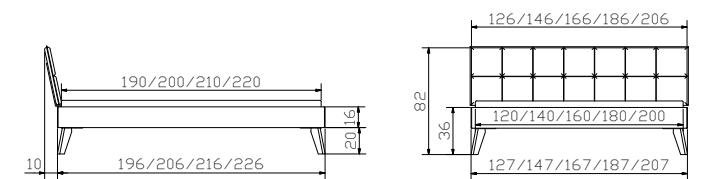

Alle Holzteile in Buche walnuss, geölt | toutes les parties en bois en hêtre teinté noyer, huilé | all wooden parts in beech walnut, oiled
Lampen und weitere Beimöbel siehe Register 2 | lampes et autres accessoires voir registre 2 | lamps and further accessories see index 2



				Dimension cm	
Amigo	Stapelbett (ohne Lattenrost)	lit superposable (sans sommier)	stacking bed (without slats)		
	Breite	largeur	width	90	
	Länge	longueur	length	200	
	Unterbett: Freiraum für Lattenroste und Matratzen 26 cm	lit inférieur: espace libre pour sommiers et matelas 26 cm	lower bed: free space for slats and mattresses 26 cm		

Alle Holzteile in Buche weiss lasiert, lackiert | toutes les parties en bois en hêtre teinté blanc lasuré, laqué | all wooden parts in beech white stained, lacquered

				Dimension cm	
Amigo	Einzelbett	lit simple	single bed		
	Breite	largeur	width	90	
	Länge	longueur	length	200	
Dupla	Nachttisch	table de nuit	bedside table	48/40/35	
Seda	Bank	banquette	bench	120/35/38	

Alle Holzteile in Kernbuche natur, geölt | toutes les parties en bois en hêtre coeur rouge naturel, huilé | all wooden parts in Heart beech natural, oiled
Weitere Beimöbel siehe Register 2 | autres accessoires voir registre 2 | further accessories see index 2

Ausführungen | exécutions | executions



- 09**
Buche weiss, lasiert, lackiert
Hêtre teinté blanc lasuré, laqué
Beech white stained, lacquered
- 80**
Kernbuche natur, geölt
Hêtre coeur rouge naturel, huilé
Heart beech natural, oiled

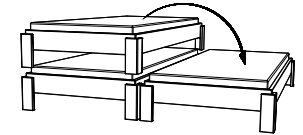
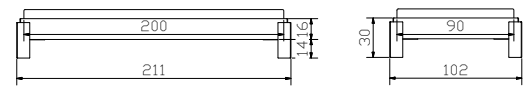

stapelbar | superposable | stackable

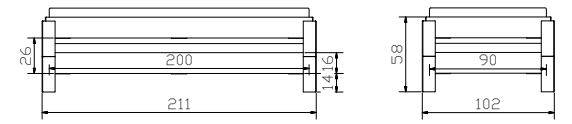



				Dimension cm
Seda	Bank	banquette	bench	120/35/38
Banc	Kissen, Casual carbon 334	coussin, Casual carbon 334	cushion, Casual carbon 334	119/34/6
Voro	Nachttisch	table de nuit	bedside table	60/49/38

				Dimension cm
Premium 18	Rahmen Breiten Längen	cadre largeurs longueurs	frame widths lengths	90, 100, 120, 140, 160, 180, 200 190 (210), 200 (220)
Tondo anthracit	Füße Höhe	pieds hauteur	feet height	20
Ceneri	Kopfteil, Casual carbon 334 hat Einfluss auf Bettlänge siehe Register 1 Seite 4	tête de lit, Casual carbon 334 a un impact sur la longueur du lit voir registre 1 page 4	headboard, Casual carbon 334 affects the length of bed see index 1 page 4	140, 160, 180, 200

Alle Holzteile in Kernbuche natur, geölt | toutes les parties en bois en hêtre coeur rouge naturel, huilé | all wooden parts in heart beech natural, oiled
Weitere Beimöbel siehe Register 2 | autres accessoires voir registre 2 | further accessories see index 2

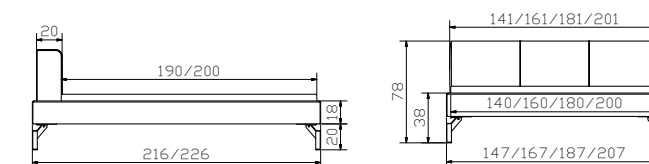



Details siehe Seite 6.9
 Détails voir page 6.9
 Details see page 6.9



				Dimension cm
Lovara	Kommode	commode	chest of drawers	90/40/75
Treva	Nachttisch	table de nuit	bedside table	48/40/51

				Dimension cm
Premium 18	Rahmen Breiten Längen	cadre largeurs longueurs	frame widths lengths	90, 100, 120, 140, 160, 180, 200 190, 200, 210, 220
Practico-Box	Breiten Längen Höhe Details siehe Seite 6.9	largeurs longueurs hauteur détails voir page 6.9	widths lengths height details see page 6.9	90, 100, 120, 140, 160, 180, 200 200, 210, 220 25
Varus	Kopfteil	tête de lit	headboard	140, 160, 180, 200
Ravo	Kissen, Campos blanc 372	coussin, Campos blanc 372	cushion, Campos blanc 372	90/100, 120, 140, 160, 180, 200

Alle Holzteile in Kernbuche natur, geölt | toutes les parties en bois en hêtre cœur rouge naturel, huilé | all wooden parts in heart beech natural, oiled
 Weitere Beimöbel siehe Register 2 | autres accessoires voir registre 2 | further accessories see index 2

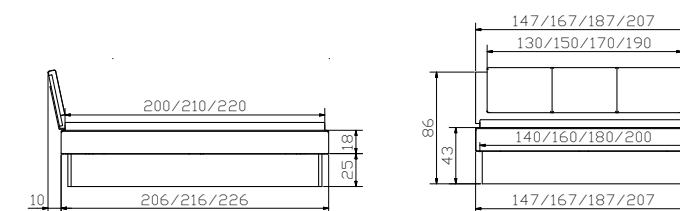



				Dimension cm
Dupla	Nachttisch	table de nuit	bedside table	48/40/35

				Dimension cm
Premium 18	Rahmen Breiten Längen	cadre largeurs longueurs	frame widths lengths	90, 100, 120, 140, 160, 180, 200 190, 200, 210, 220
Cielo	Baldachin Breiten Längen Höhen	baldaquin largeurs longueurs hauteurs	canopy widths lengths heights	120, 140, 160, 180, 200 200/210/220 20
Duetto	Kopfteil	tête de lit	headboard	90/100, 120, 140, 160, 180, 200



Curty

Alle Holzteile in Buche weiss lasiert, lackiert | toutes les parties en bois en hêtre teinté blanc lasuré, laqué | all wooden parts in beech white stained, lacquered

Weitere Beimöbel siehe Register 2 | autres accessoires voir registre 2 | further accessories see index 2

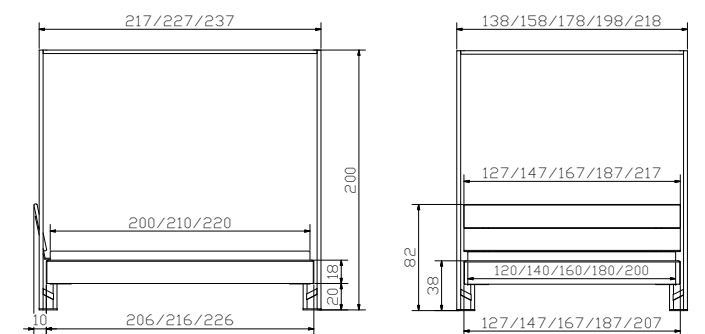



Dimension cm

Voro	Nachttisch	table de nuit	bedside table	
Rivo copper	Griffe (2er Set)	poignées (set de 2)	handles (set of 2)	60/49/38

Dimension cm

Premium 18	Rahmen Breiten Längen	cadre largeurs longueurs	frame widths lengths	90, 100, 120, 140, 160, 180, 200 190, 200, 210, 220
Cantu	Füße Höhen	pieds hauteurs	feet heights	20, 25, 30
Ripo	Kopfteil, Shine rose 681 siehe Register 1	tête de lit, Shine rose 681 voir registre 1	headboard, Shine rose 681 see index 1	90, 100, 120, 140, 160, 180, 200

Alle Holzteile in Buche schoko, lackiert | toutes les parties en bois en hêtre teinté chocolat, laqué | all wooden parts in beech chocolate, lacquered
Weitere Beimöbel siehe Register 2 | autres accessoires voir registre 2 | further accessories see index 2

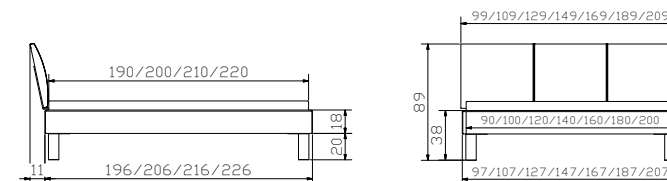



				Dimension cm
Aska	Sekretär	secrétaire	bureau	120/60/85
Tree	Nachttisch/Hocker	table de nuit/tabouret	bedside table/stool	Ø 42/44
Silvio alu	Herrendiener	valet	dressboy	45/28/103
Treva	Nachttisch	table de nuit	bedside table	48/40/51

				Dimension cm
Premium 23	Rahmen Breiten Längen	cadre largeurs longueurs	frame widths lengths	120, 140, 160, 180, 200 200, 210, 220
Leno	Füße Höhe	pieds hauteur	feet height	20, 25
Cussina	Kopfteil, Ranch stone 660 siehe Register 1	tête de lit, Ranch stone 660 voir registre 1	headboard, Ranch stone 660 see index 1	140, 160, 180, 200

Alle Holzteile in Kernbuche natur, geölt | toutes les parties en bois en hêtre coeur rouge naturel, huilé | all wooden parts in heart beech natural, oiled

Tree in Echtbeton | Tree en beton véritable | Tree in real concrete

Weitere Beimöbel siehe Register 2 | autres accessoires voir registre 2 | further accessories see index 2

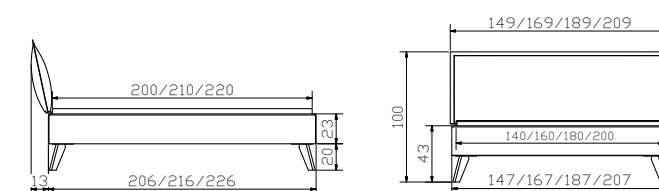



	Dimension cm			
Lovie-Box	1 Bettkasten Breiten	1 tiroir de lit largeurs	1 bed drawer widths	90, 100, 120, 140
	2 Bettkästen Breiten	2 tiroirs de lit largeurs	2 bed drawers widths	140, 160, 180, 200
	Höhe	hauteur	height	25

	Dimension cm			
Premium 23	Rahmen Breiten Längen	cadre largeurs longueurs	frame widths lengths	120, 140, 160, 180, 200 200, 210, 220
Slid white	Kufen Breiten Höhen	patins largeurs hauteurs	vats widths heights	140, 160, 180, 200 20, 25
Obag	Kopfteil, Campos blanc 372 siehe Register 1	tête de lit, Campos blanc 372 voir registre 1	headboard, Campos blanc 372 see index 1	140, 160, 180, 200
Aska	Sekretär	secrétaire	bureau	120/60/85
Tree	Nachttisch/Hocker	table de nuit/tabouret	bedside table/stool	Ø 42/44
Voro	Nachttisch	table de nuit	bedside table	60/49/38

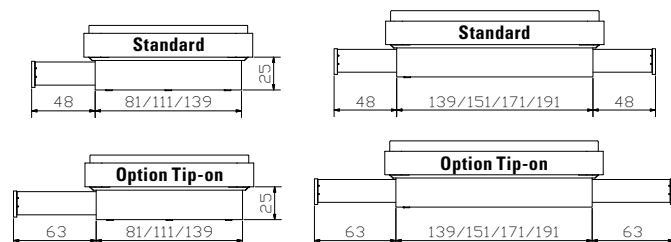

Alle Holzteile in Buche weiss lasiert, lackiert oder Buche weiss, deckend | toutes les parties en hêtre teinté blanc lasuré, laqué ou hêtre blanc, couvrant | all wooden parts in beech white stained, lacquered or beech white covered

Tree in Echtbeton | Tree en béton véritable | Tree in real concrete

Weitere Beimöbel siehe Register 2 | autres accessoires voir registre 2 | further accessories see index 2

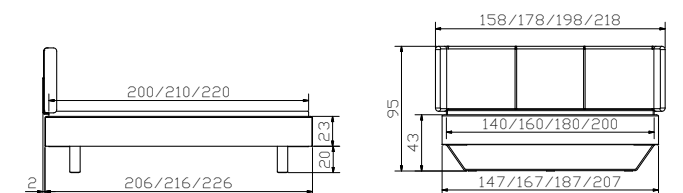





				Dimension cm
Covaro	Kommode	commode	chest of drawers	120/49/90
Seda	Bank	banquette	bench	120/35/38
Banc	Kissen, Kitana aqua 603	coussin, Kitana aqua 603	cushion, Kitana aqua 603	119/34/6
Treva	Nachttisch	table de nuit	bedside table	48/40/51
Snake alu	Lampen (2er Set) 12V DC, 6 LED 3 Beleuchtungsarten	lampes (set de 2) 12V DC, 6 LED 3 différent illuminations	lamps (set of 2) 12V DC, 6 LED 3 different illuminations	

				Dimension cm
Premium 23	Rahmen Breiten Längen	cadre largeurs longueurs	frame widths lengths	120, 140, 160, 180, 200 200, 210, 220
Juve	Füße Höhe	pieds hauteur	feet height	20, 25
Sogno L	Wandpaneel, Kitana aqua 603 siehe Register 1	panneau mural, Kitana aqua 603 voir registre 1	wall panel, Kitana aqua 603 see index 1	161, 181, 201, 221

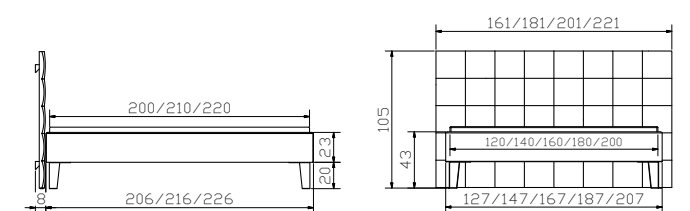
Alle Holzteile in Buche schoko, lackiert | toutes les parties en bois en hêtre teinté chocolat, laqué | all wooden parts in beech chocolate, lacquered
Lampen und weitere Beimöbel siehe Register 2 | lampes et autres accessoires voir registre 2 | lamps and further accessories see index 2





				Dimension cm
Lovara	Kommode	commode	chest of drawers	90/40/75
Treva	Nachttisch	table de nuit	bedside table	48/40/51
Boa chrom	Lampen (2er Set) 12V DC, 12 LED warm	lampes (set de 2) 12V DC, 12 LED warm	lamps (set of 2) 12V DC, 12 LED warm	

				Dimension cm
Premium 23	Rahmen Breiten Längen	cadre largeurs longueurs	frame widths lengths	120, 140, 160, 180, 200 200, 210, 220
Cantu	Füße Höhe	pieds hauteur	feet height	20, 25, 30
Talma	Kopfteil, Ranch grit 661 siehe Register 1	tête de lit, Ranch grit 661 voir registre 1	headboard, Ranch grit 661 see index 1	140, 160, 180, 200

Alle Holzteile in Buche kirschbaumfarbig, lackiert | toutes les parties en bois en hêtre teinté merisier, laqué | all wooden parts in beech cherry coloured, lacquered
Lampen und weitere Beimöbel siehe Register 2 | lampes et autres accessoires voir registre 2 | lamps and further accessories see index 2

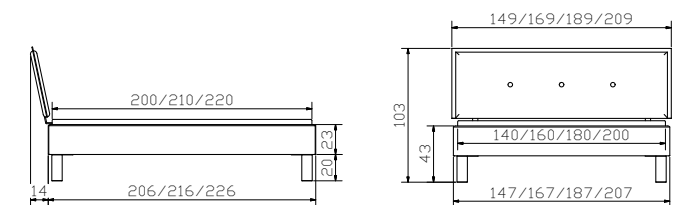



Dimension cm

Varus	Kopfteil	tête de lit	headboard	140, 160, 180, 200
Varo	Kissen (2er Set), Boston tizo 654	coussins (set de 2), Boston tizo 654	cushions (set of 2), Boston tizo 654	55/10/35
Duetto	Kopfteil	tête de lit	headboard	140, 160, 180, 200
Lumo	Kissen, Boston tizo 654	coussin, Boston tizo 654	cushion, Boston tizo 654	140, 160, 180/200

Dimension cm

Premium 23	Rahmen	cadre	frame	120, 140, 160, 180, 200
	Breiten	largeurs	widths	200, 210, 220
	Längen	longueurs	lengths	
Slid anthracit	Kufen	patins	vats	140, 160, 180, 200
	Breiten	largeurs	widths	20, 25
	Höhen	hauteurs	heights	
Varus	Kopfteil	tête de lit	headboard	140, 160, 180, 200
Ravo	Kissen, Boston tizo 654	coussin, Boston tizo 654	cushion, Boston tizo 654	140, 160, 180, 200
Lovara	Kommode	commode	chest of drawers	90/40/75
Dupla	Nachttisch	table de nuit	bedside table	48/40/35

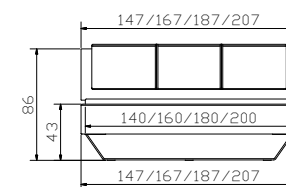
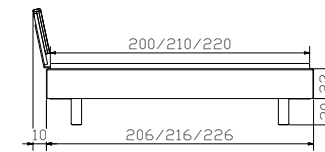
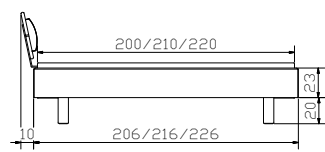
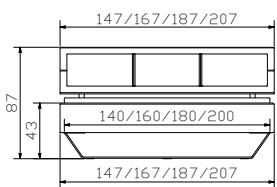
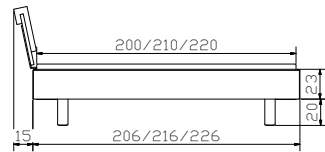
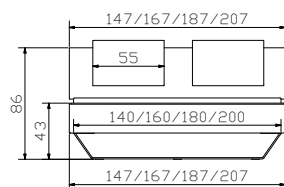

Alle Holzteile in Buche walnuss, geölt | toutes les parties en bois en hêtre teinté noyer, huilé | all wooden parts in beech walnut, oiled

Weitere Beimöbel siehe Register 2 | autres accessoires voir registre 2 | further accessories see index 2



Komfortbett mit Stauraum

lit confortable avec espace de rangement | comfort bed with storage space

Spazio

Details und weitere Ausführungen siehe Register 12, Seiten 10 – 21 | détails et autres versions voir registre 12, pages 10 – 21 | details and further versions see index 12, pages 10 – 21