









swiss bed concept









# BOX Spring Accessoires



Achten Sie auf FSC®-zertifizierte Produkte | soyez attentifs aux produits certifiés FSC® | look for FSC®-certified products

	Technische Details Détails techniques Technical details	Lichtquelle/-regulierung Source lumineuse/régulation lumière Light source/-regulation	Bedienung Utilisation Handling
<b>Boa</b> 	12V DC, 12 LED, 60 lm	<b>LED kalt weiss / einstufig</b> de lumière blanche froide/ interrupteur à 1 cran cold white/one level	<b>Touch-Sensor am Lampenkopf</b> Touche sensorielle à la tête de la lampe Touch-sensor at lamphead
<b>Smart</b> 	12V DC, 30 LED warm, 183 lm <b>Dreistufenschaltung</b> Interrupteur à 3 crans Three-step circuit	<b>LED warm weiss / 3 Helligkeitsstufen</b> de lumière blanche chaude / interrupteur à 3 crans warm white / 3 level	<b>Druckknopf am Lampenkopf</b> Bouton-poussoir à la tête de la lampe Push button at lamphead
<b>Snake</b> 	12V DC, 6 LED, 110 lm <b>3 Beleuchtungsarten</b> 3 différent illuminations 3 different illuminations	<b>LED 3-stufig = Lichtwahl kalt weiss, warm oder kalt/warm gemischt</b> Interrupteur à 3 crans = choix de lumière blanche froide, chaude ou froide/chaude mélangées 3 level = choice of light cold white, warm or cold/warm mixed	<b>Druckknopf am Lampenkopf</b> Bouton-poussoir à la tête de la lampe Push button at lamphead
<b>Tina</b> 	12V DC, 1 LED, 75 lm	<b>LED Licht neutral weiss</b> Lumière blanc neutre Light neutral white	<b>Druckknopf am Lampenkopf</b> Bouton-poussoir à la tête de la lampe Push button at lamphead
<b>LED-Light-Profil</b> 	<b>Sockelbeleuchtung, LED Flexiband, 10 x 10 mm Profilleuchten</b> 12V DC, 27,9 W, 60 LED/m <b>warm weiss</b> Éclairage de socle, LED band flexible, 10 x 10 mm luminaires profilés 12V DC, 27,9 W, 60 LED/m blanc chaud Socket lighting, LED flexible strip, 10 x 10 mm profile luminaires 12V DC, 27,9 W, 60 LED/m warm white	<b>LED Lichtfarbe 3200-3500K, warm weiss</b> Couleur de lumière 3200-3500K, blanc chaud Light colour 3200-3500K, warm white	<b>Funkschalter zum Ein-/Ausschalten und Dimmen</b> Interrupteur sans fil pour allumer/ éteindre ou baisser Radio switch to switch on/off and to dim
<b>für Sockelbeleuchtung von Rocc, Boca und Forma</b> éclairage de socle pour Rocc, Boca et Forma socket lighting for Rocc, Boca and Forma	<b>LED Transformator  </b> transformateur   transformator 12V DC, 2,4 A, 30 W, 100-240 Volt		

Ausführung Exécution Execution		
<b>Boa chrom</b> 	<b>Flexarm und Kopf in chrom</b> Bras flexible et tête en chrome Flexible arm and lamphead in chrome	
<b>Smart black</b> 	<b>Flexarm und Kopf in weiss oder schwarz</b> Bras flexible et tête en blanc ou noir Flexible arm and lamphead in white or black	<b>Smart white</b> 
<b>Snake alu</b> 	<b>Flexarm und Kopf alufarbig</b> Bras flexible et tête en teinté alu Flexible arm and lamphead alucoloured	
<b>Tina chrom</b> 	<b>Flexarm und Kopf in chrom</b> Bras flexible et tête en chrome Flexible arm and lamphead in chrome	
<b>Combino</b> 		
<b>Bei Kopfteilen Lyon und Florenz sind die Lampen nicht montierbar</b>   les lampes ne peuvent pas être montées sur les têtes de lit Lyon et Florence   lamps cannot be fitted to the headboards Lyon and Florence		<b>Adapter für die Lampen</b>   adaptateur pour les lampes   adapter for the lamps <b>Boa, Smart, Snake, Tina</b>  <b>Adapter zur Befestigung der Lampen an folgenden Kopfteilen, Wandpaneelen und Betten Pronto</b>   adaptateur pour la fixation des lampes aux têtes de lit, panneaux muraux et des lits Pronto   adapter to mount the lamps to the following headboards, wallpanels and Pronto beds  <b>Lille, Nizza, Palermo, Milano, Azina Colina</b>  <b>Pronto: Bella, Costa, Denver, Finca, Fleur, Lodge, Miami, Scandia</b>

# Nachttische | tables de nuit | bedside tables



# Nachttische | tables de nuit | bedside tables



**Passende Füße und Griffe, siehe Seite 1.7**  
Pieds et poignées assortis, voir page 1.7  
Suitable feet and handles, see page 1.7

Holzfarben (Ansicht Farben siehe Seite 1.14) | couleurs bois (voir couleurs page 1.14) | wood colours (see colours page 1.14)

	06	07	08	09	10	16	30	35	49	50	55	59	61	62	64	71	73	80	81	85	86	87	89	90	91	92	93	96	98
Brig																													
Butch																													
Cali																													
Cara																													
Carpi																													
Cera																													
Cerina																													
Cervo																													
Circo																													
Cubo																													
Drema																													
Dupla																													
Esto																													
Flims																													
Koro																													
Lina																													
Lona																													
Ludo																													
Menza																													
Mino																													
Nali																													
Noma																													
Osta																													
Pero																													
Plato																													
Primea																													
Quora																													
Rio																													
Sica																													
Tercio																													
Treva																													
Trigo																													
Trino																													
Triore																													
Turo																													
Vera																													
Voro																													

# Kommoden | commodes | chests of drawers

Aida

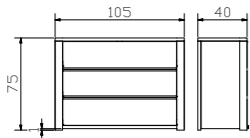

Alto FSC

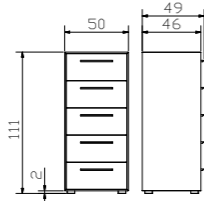

Basso

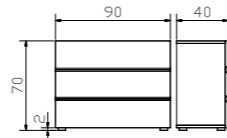

Casia + Jone FSC

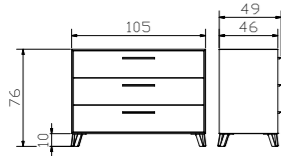

Cassetto

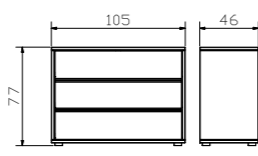

Cessa

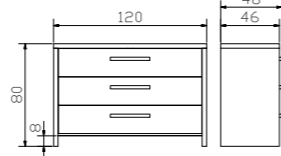

Covaro FSC

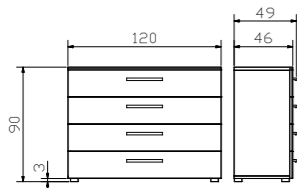

Lovara FSC

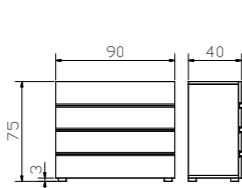

## Blumotion



Für unsere Nachttische und Kommoden verwenden wir ausschliesslich den gedämpften Selbsteinzug Blumotion von BLUM.  
Pour nos tables de nuit et commodes nous utilisons exclusivement les tiroirs avec système d'amortissement Blumotion de BLUM.  
For our bedside tables and chests of drawers we utilize exclusively the silent and soft self closing drawer runner Blumotion of BLUM.

# Kommoden | commodes | chests of drawers

Rivera FSC

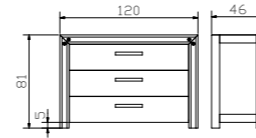

Sigma

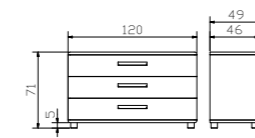

Viola FSC

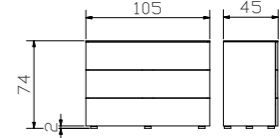

Holzfarben (Ansicht Farben siehe Seite 1.14) | couleurs bois (voir couleurs page 1.14) | wood colours (see colours page 1.14)

	06	07	08	09	10	16	30	35	49	50	55	59	61	62	64	73	80	81	85	86	87	89	90	91	92	93	96	98	
Aida																													
Alto																													
Basso																													
Casia																													
Cassetto																													
Cessa																													
Covaro																													
Lovara																													
Rivera																													
Sigma																													
Viola																													

## Füsse | pieds | feet

Sima 10/20



Jone 10\*  
anthracit, white, used



Leg 8

alu, chrom, inox



Tindo 10\*

alu, anthracit, bronze, copper



Piedo 8

alu, chrom



Cua 7



Roll 8

alu, chrom



Loa 7



Fuss Set (4 Stk.) | set de pieds (4 pcs) | set of feet (4 pcs)

## Option zu | option pour | option to:

Nachttische | tables de nuit | bedside tables

Cerina\*  
Drema\*  
Dupla\*  
Menza\*  
Mino  
Noma  
Sica  
Trigo  
Trino  
Triore  
Vera  
Voro\*

Kommoden | commodes | chests of drawers

Alto  
Basso\*  
Casia  
Cassetto  
Covaro\*  
Lovara\*  
Sigma  
Viola

\*nicht montierbar | montage impossible | not mountable

## Griffe | poignées | handles

Covo

Alu



Chrom



Inox



Seca

Iron



Anthracit



Rivo

Used



Anthracit



Bronze



Copper



## Option zu | option pour | option to:

Nachttische | tables de nuit | bedside tables

Cera  
Cerina  
Cervo  
Noma  
Rio  
Sica  
Trigo  
Trino  
Voro

Kommoden | commodes | chests of drawers

Alto  
Casia  
Cessa  
Covaro  
Rivera  
Sigma

**Nachttische, Kommoden** | tables de nuit, commodes | bedside tables, chests of drawers

**Modo**



**Tola**



**Chest**



**Modo, Tola, Chest**  
 standardmässig mit Holzgriffen, optional Covo, Seca und Rivo Griffe  
 Korpus = MDF betonfarbig lackiert, Innenschubladen = Akazie massiv, grau lackiert; Fronten in allen aufgeführten Holz Ausführungen erhältlich |  
 standard avec poignées en bois, en option poignées Covo, Seca et Rivo  
 corps = mdf teinté béton, laqué; tiroirs intérieur = acacia massif, gris lacqué, façades dans tous les exécutions en bois mentionnés disphestonible |  
 with wooden handles standard, optional Covo, Seca and Rivo handles  
 corpus = mdf concrete coloured, lacquered; inside drawers = solid acacia, grey lacquered, fronts in all listed wooden executions available

**Füsse** | pieds | feet



**Fuss Set (4 Stk.)** | set de pieds (4 pcs) | set of feet (4 pcs)

**Griffe** | poignées | handles



**Nachttische, Kommoden** | tables de nuit, commodes | bedside tables, chests of drawers

**Duqa anthracit**

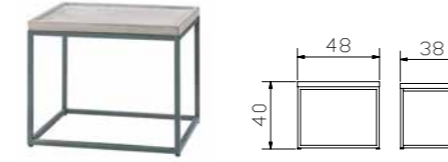

**Pira**

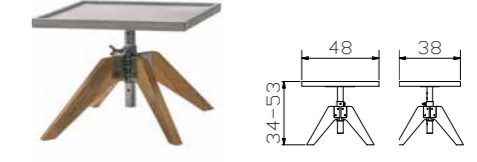

**Rico 46 + 54**



**Tree**



**Beton** | béton | concrete



**20**  
**Beton grey**  
 béton grey  
 concrete grey

**Duqa, Pira, Rico = Auflageplatte Echtbeton** | plaque d'appui béton véritable | support plate real concrete  
**Tree = Echtbeton, Farb- und Strukturunterschiede sind naturbedingte Eigenschaften** | béton véritable, les différences de couleurs et structures sont des particularités naturelles | real concrete, differences in colour and structures are natural characteristics

**Farben (Ansicht Farben siehe Seite 1.14)** | couleurs (voir couleurs page 1.14) | colours (see colours page 1.14)

	00	04	10	16	20	40	41	42	43	45	62	64	71	73	80	85	87	90	92	93	96
Chest			•		•						•	•			•	•		•		•	
Duqa				•	•																
Modo			•		•							•	•		•	•		•		•	
Pira					•							•	•					•		•	
Rico					•									•							
Tola			•		•							•	•		•	•		•		•	
Tree					•																
<b>Füsse</b>   pieds   feet																					
Cua																					•
Jone		•	•	•																	
Leg	•							•	•												
Loa																					•
Piedo									•												
Roll									•												
Sima				•																	
Tindo					•		•	•	•					•	•	•				•	
<b>Griffe</b>   poignées   handles																					
Covo	•								•	•											
Rivo		•			•	•															
Seca				•						•											

**Ausführungen Metall** | exécutions métal | executions metal

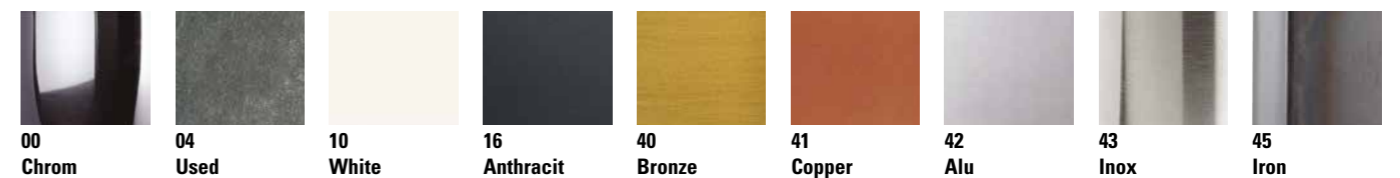

**Chrom = Metall verchromt** | métal chromé | metal chrome-plated  
**Used = Metall galvanisiert** | métal galvanisé | metal galvanised  
**White = Metall pulverbeschichtet** | métal thermolaqué | metal powder-coated  
**Anthracit = Metall pulverbeschichtet** | métal thermolaqué | metal powder-coated  
**Bronze = Metall lackiert** | métal laqué | metal lacquered

**Copper = Metall lackiert** | métal laqué | metal lacquered  
**Alu = Metall pulverbeschichtet** | métal thermolaqué | metal powder-coated  
**Inox = Edelstahl gebürstet** | acier inoxydable brossé | stainless steel brushed  
**Iron = Metall geflammt, pulverbeschichtet** | métal flammé, thermolaqué | metal mottled, powder-coated

## Bank + Kissen | banquette + coussin | bench + cushion

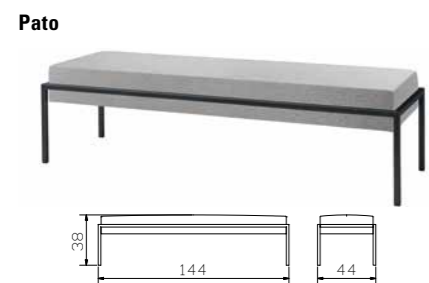
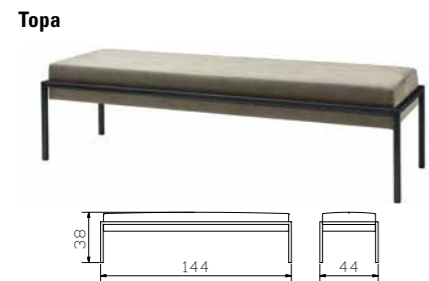
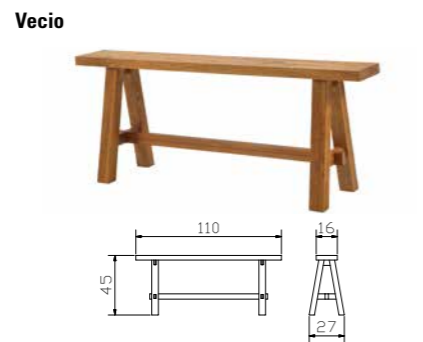
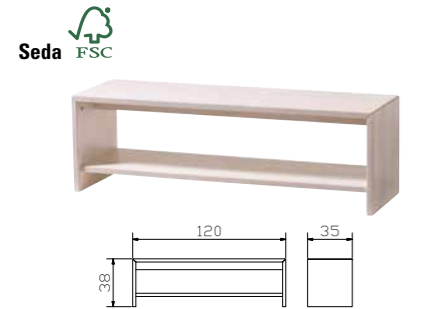
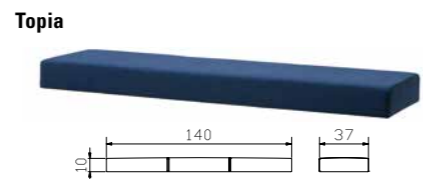
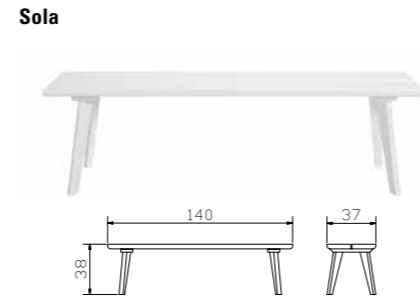
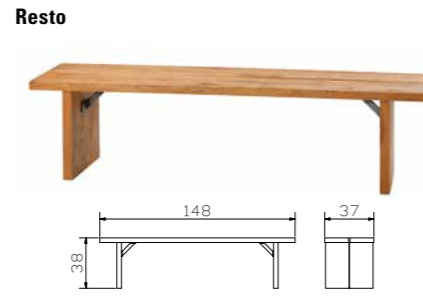

**Stoffauswahl Pato (Pronto) | choix de tissus Pato (Pronto) | choice of fabrics Pato (Pronto)**



**Weitere Informationen siehe Register 8 | davantage informations plus détaillées voir registre 8 | other detailed information see index 8**

## Atrium alu, anthracit

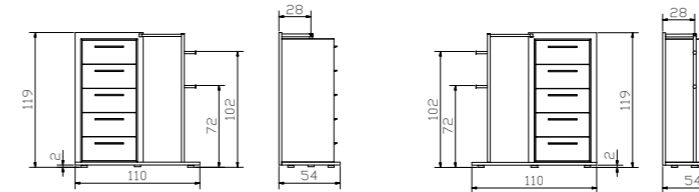

**Metallstange/Rückplatte links und rechts montierbar, inklusive Holzablage Tray**  
barre métallique/plaque arrière peut être montée à gauche et à droite, vide poche Tray inclus  
**metal bar/back plate can be assembled left and right, wood tray included**



**Option: Tray Holzablage für Atrium + Atrio**  
vide poche pour Atrium + Atrio  
wood tray for Atrium + Atrio

## Herrendiener | valet | dressboy

**Emilio** alu, chrom

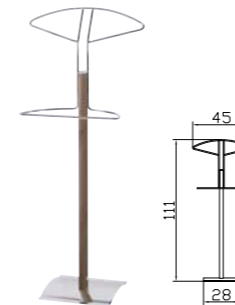

**Claudio** alu, anthracit, iron

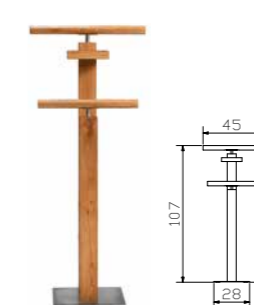

**Silvio** alu, anthracit, inox



**Farben (Ansicht Farben siehe Seite 1.14) | couleurs (voir couleurs page 1.14) | colours (see colours page 1.14)**

	06	07	09	10	16	20	30	40	41	61	62	64	73	80	85	86	87	89	90	91	93	96	98	
Atrio				•	•																			
Atrium				•	•										•	•								
Banco										•	•	•												
Calmo																						•	•	
Claudio														•										
Emilio				•	•		•																	
Pato					•																			
Resto																					•	•	•	
Seda	•	•	•																					
Sola				•										•	•	•	•				•			
Silvio				•											•	•								
Topa					•			•	•															
Tray				•		•									•	•								
Vecio																					•	•	•	•

## Sekretär | secrétaire | bureau

Aska

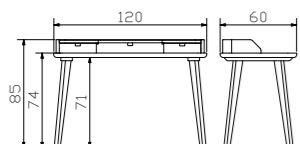

Coset

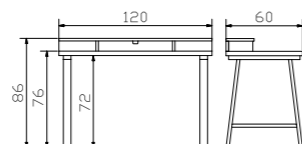

Scola

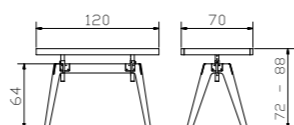

mit Schreibunterlage aus Kunstleder  
**Casual carbon 334**  
sous-main de bureau en cuir synthétique  
Casual carbon 334  
deskpad in synthetic leather Casual carbon 334

## Schreibtisch | bureau | desk

Study

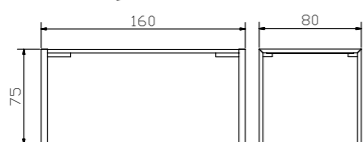

Ausführung: Tischplatte MDF mit Melamin-Folie beschichtet, Füsse aus Stahl pulverbeschichtet  
Exécution : Plateau MDF mélaminé, pieds en acier thermolaqués  
Execution: Tabletop in mdf laminated with melamine, feet are of steel powder-coated

Farben | couleurs | colours

	10	16	61	62	64	73	80	85	86	89	90	91	93	96	98
Aska	•					•	•	•	•	•		•			
Coset											•		•	•	•
Scola			•	•	•										
Study	•	•													

Holz | bois | wood

<b>06</b> Buche natur, lackiert Hêtre naturel, laqué Natural beech, lacquered	<b>07</b> Buche schoko, lackiert Hêtre teinté chocolat, laqué Beech chocolate coloured, lacquered	<b>08</b> Buche kirschbaumfarbig, lackiert Hêtre teinté merisier, laqué Beech cherry coloured, lacquered	<b>09</b> Buche weiss, lasiert, lackiert Hêtre teinté blanc lasuré, laqué Beech white stained, lacquered	<b>10</b> Buche weiss deckend, lackiert Hêtre blanc couvrant, laqué Beech white covered, lacquered	<b>20</b> Beton grey béton grey concrete grey
<b>61</b> Akazie Vintage white, lackiert Acacia Vintage white, laqué Acacia Vintage white, lacquered	<b>62</b> Akazie Vintage brown, lackiert Acacia Vintage brown, laqué Acacia Vintage brown, lacquered	<b>64</b> Akazie Vintage grey, lackiert Acacia Vintage grey, laqué Acacia Vintage grey, lacquered	<b>71</b> Eiche bianco, stabverleimt, geölt Chêne bianco, lamellé-collé, huilé Oak bianco, plywood, oiled	<b>73</b> Eiche bianco, gebürstet, geölt Chêne bianco, brossé, huilé Oak bianco, brushed, oiled	<b>80</b> Kernbuche natur, geölt Hêtre coeur rouge naturel, huilé Heart beech natural, oiled
<b>81</b> Buche walnuss, geölt Hêtre teinté noyer, huilé Beech walnut, oiled	<b>85</b> Nussbaum, geölt Noyer, huilé Walnut, oiled	<b>86</b> Eiche natur, gebürstet, geölt Chêne naturel, brossé, huilé Oak natural, brushed, oiled	<b>87</b> Wildbuche natur, geölt Hêtre nouveaux naturel, huilé Wildbeech natural, oiled	<b>89</b> Eiche graphit, gebürstet, geölt Chêne graphit, brossé, huilé Oak graphit, brushed, oiled	<b>90</b> Wildecke Vintage natur, geölt Chêne nouveaux Vintage naturel, huilé Wildoak Vintage natural, oiled
<b>91</b> Eiche cognac, gebürstet, geölt Chêne cognac, brossé, huilé Oak cognac, brushed, oiled	<b>92</b> Kernesche natur, lackiert Frêne coeur noir naturel, laqué Heart ash natural, lacquered	<b>93</b> Wildecke natur, gebürstet, geölt Chêne nouveaux naturel, brossé, huilé Wildoak natural, brushed, oiled	<b>96</b> Wildecke pure, gebürstet, geölt Chêne nouveaux pure, brossé, huilé Wildoak pure, brushed, oiled	<b>98</b> Wildecke coffee, gebürstet, geölt Chêne nouveaux coffee, brossé, huilé Wildoak coffee, brushed, oiled	

## Holz-Nachbildungen | bois laminé | wood laminated

<b>10</b> Weiss Blanc White	<b>16</b> Anthracit	<b>30</b> Walnuss Noyer Walnut	<b>35</b> Hochglanz weiss Blanc brillant White highgloss
<b>49</b> Beton Nachbildung Beton laminé Beton laminated	<b>50</b> Eiche sägerauh natur Chêne brut de sciage naturel Oak rough sawn natural	<b>55</b> Esche hell Frêne clair Ash light	<b>59</b> Buche Hêtre Beech

# Stoff- und Kunstlederauswahl | choix de tissus et cuirs synthétiques | choice of fabrics and synthetic leathers

## 3. Preiskategorie | 3<sup>e</sup> catégorie de prix | 3<sup>rd</sup> price range

### Alpina 390–394, 100% Polyester



390 lightgrey    391 anthrazit    392 red    393 navy    394 smoke

### Boston 650–654, Oberfläche | surface: 100% Polyester, Basis | base: 70% Polyester, 30% Baumwolle | coton | cotton



650 clay    651 bean    652 mocca    653 turtle    654 tizo

### Campos 372–376, Kunstleder | cuir synthétique | synthetic leather

Oberfläche | surface: 100% Polyurethan | polyurethane, Basis | base: 71% Polyester, 29% Baumwolle | coton | cotton



372 blanc    373 creme    374 cafe    375 nero    376 kit

### Casual 330–334, Kunstleder | cuir synthétique | synthetic leather

Oberfläche | surface: 100% Polyurethan | polyurethane, Basis | base: 60% Polyester, 40% Baumwolle | coton | cotton



330 sahara    331 cannelle    332 cognac    333 olive    334 carbon

### Kabo 630–634, 100% Polyester



630 calc    631 rust    632 apple    633 lagoon    634 belle

### Kitana 600–604, 100% Polyester

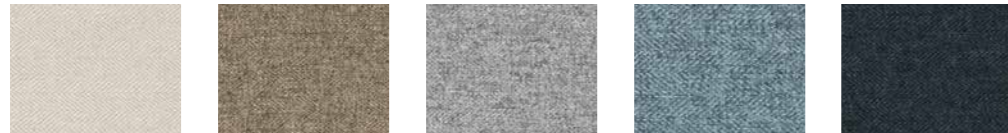

600 beige    601 nougat    602 grigio    603 aqua    604 anthrazit

### Ranch 660–664, 100% Baumwolle | coton | cotton



660 stone    661 grit    662 jeans    663 indigo    664 hunter

### Shine 680–685, 100% Polyester



680 wine    681 rose    682 opal    683 musk    684 curry    685 stone